

MEGORAS Technology - TB6600 STEP MOTOR Driver

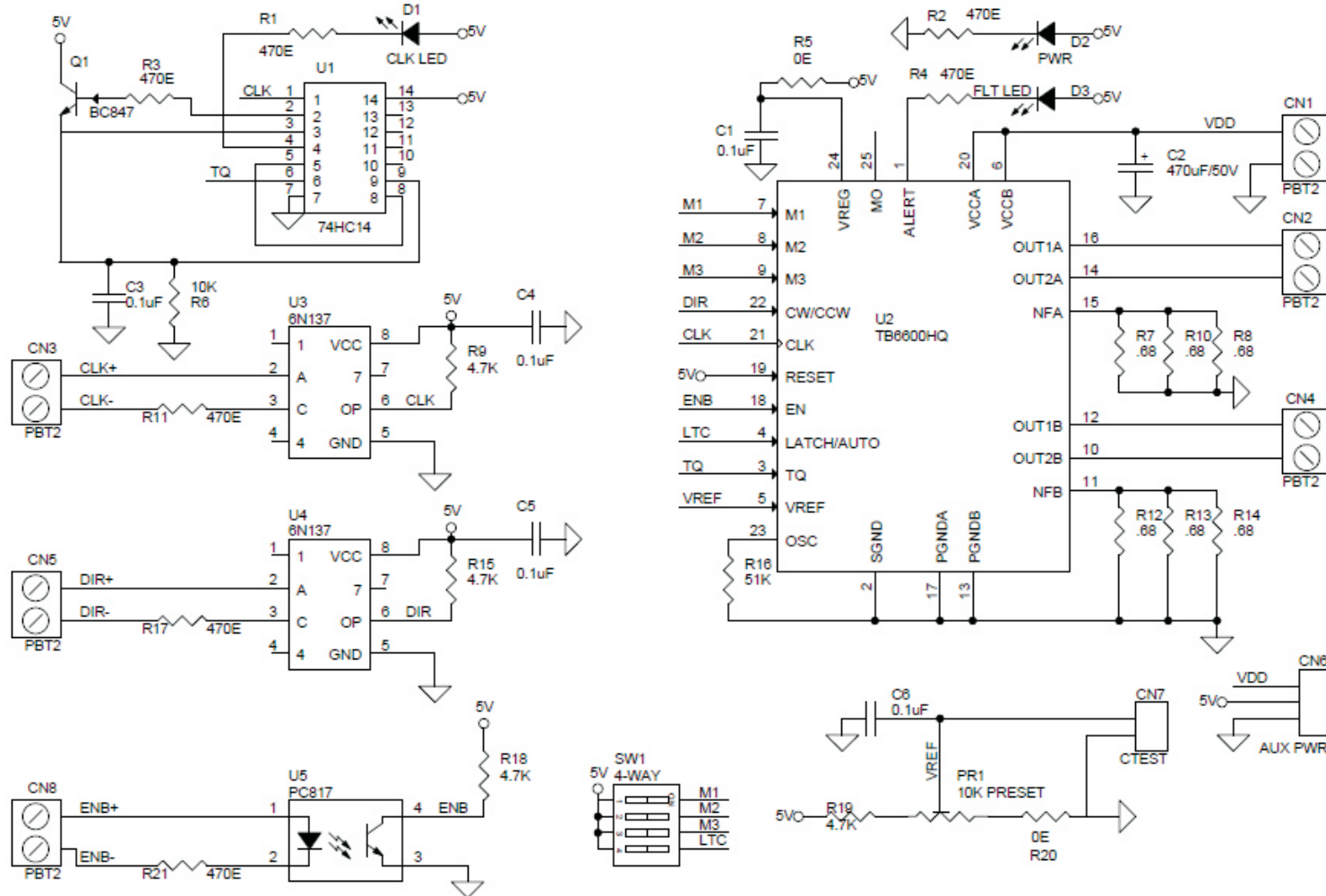

MEGORAS Technology - TB6600 STEP MOTOR Driver

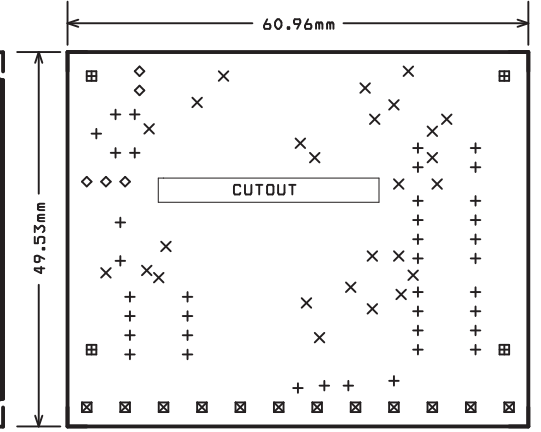
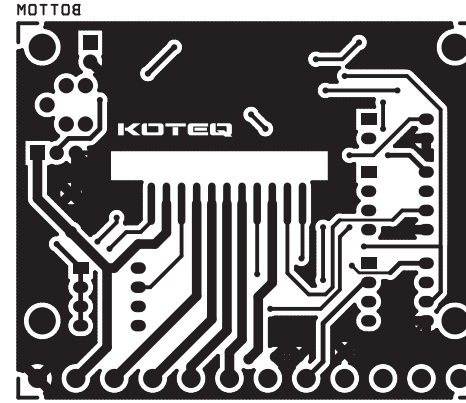
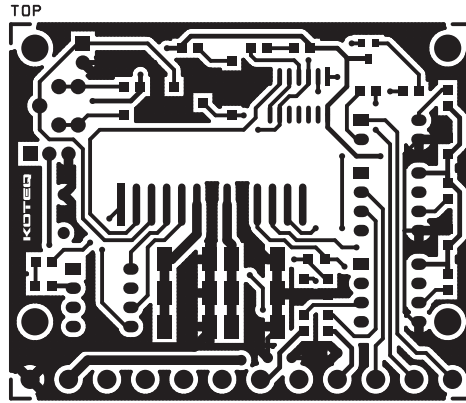
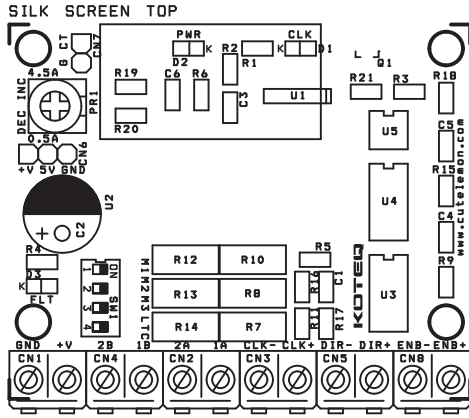

BOM			
SR.	QNTY.	REF.	DESC.
1	6	CN1,CN2,CN3,CN4,CN5,CN8	2 PIN SCREW TERMINAL
2	1	CN6	3 PIN HEADER CONNECTOR
3	1	CN7	2 PIN HEADER CONNECTOR
4	5	C1,C3,C4,C5,C6	0.1uF SMD 0805
5	1	C2	470uF/50V
6	1	D1	RED LED SMD 0805
7	1	D2	RED LED SMD 0805
8	1	D3	RED LED SMD 0805
9	1	PR1	10K PRESET
10	1	Q1	BC847 SMD
11	7	R1,R2,R3,R4,R11,R17,R21	470E SMD 0805
12	2	R5,R20	0E SMD 0805
13	1	R6	10K SMD 0805
14	6	R7,R8,R10,R12,R13,R14	0.68 SMD 2512
15	4	R9,R15,R18,R19	4.7K SMD 0805
16	1	R16	51K SMD 0805
17	1	SW1	4-WAY DIP SWITCH
18	1	U1	74HC14 SMD SO14
19	1	U2	TB6600HQ
20	2	U3,U4	6N137 DIP 8
21	1	U5	PC817 DIP 4

MEGORAS Technology - TB6600 STEP MOTOR Driver

Bipolar stepper drive board described here has been designed around TB6600HG IC. The TB6600HG is PWM chopper type single chip bipolar sinusoidal micro-step stepping driver.

Features

- Based on Single chip
- Suitable for Nema17, Nema23, Nema34 bipolar stepper motors
- Suitable for 4Wires, 6 wires and 8 wires stepper motor.
- Forward and reverse rotations available
- Selectable Phase (Micro-step) drives 1/1, 1/2, 1/4, 1/8, and 1/16
- Maximum Input supply 42V DC Minimum Input supply 10V DC
- Output current 4.5Amps
- Output Fault Monitor LED indicator
- On Board Power LED indicator
- On Board step pulse input LED indicator
- Standby auto half current reduction circuitry onboard
- Built in Thermal shutdown (IC)
- Built in under voltage lock out (UVLO) circuit (IC)
- Built in over current detection (ISD) circuit (IC)
- Large capacitor to handle inrush current

Applications

- Robotics
- Large format Size Printers
- CNC
- Routers
- 3D Printers
- Machine Automations
- Camera Pan Tilt Heads
- Slot Machines
- Vending Machines

4 X DIP SWITCH SETTINGS

LATCH : ON=Automatic Return if Thermal Shutdown Or Over Current Detection,
LATCH : OFF Its return to normal operation on power on

Micro-Stepping (Excitations Settings)			
M1	M2	M3	Operations
OFF	OFF	ON	Full step 1/1
OFF	ON	OFF	1/2A type (1-2 phase excitation A type) 0% - 71% - 100%
OFF	ON	ON	1/2B type (1-2 phase excitation B type) 0% - 100%
ON	OFF	OFF	1/4 Step
ON	OFF	ON	1/8Step
ON	ON	OFF	1/16Step
ON	ON	ON	Standby (Operation of the internal circuit almost turned off
OFF	OFF	OFF	Standby (Operation of the internal circuit almost turned off

Heat-sink and Thermal Shutdown

The board has sense resistors and these resistors has been set as per maximum load current 4.5A, If you use lower current motor, please set the PR1-Preset (Potentiometer) to the required level for the motor. At maximum current load TB6600 IC will overheat in some time and a RED LED turns on. This LED goes off once the temperature falls to a safe operating level.

For maximum load current Drive required a forced air cooling, better to have fan and large heat-sink other than the provided heat sink

Micro Stepping

A 4way DIP switch is used to set the micro step modes (Full, Half, Eight, Sixteenth), please see the table for Micro step settings. DIP Switch settings should be changed when power is off so the correct selection is active at power up.

Step Pulse

Minimum positive duty cycle of the input step pulse should be 2.2us and required 5V (TTL) signal. A positive going pulse on the step input activates a step operation.

Current Settings

Average drive current can be set using a Preset (On Board PR1 Potentiometer). CN7 (CT) onboard connector is provided to measure the voltage to set the motor current (torque). Voltage range to set the torque 0.3V to 3.5V

Cautions

- Never connect or remove supply wires, motor wires, or input interface when power is on, this can cause damage to drive.
- Never set the dip switch when power is on.
- Before using this drive, please have proper information about stepper motors, Motor impedance, Inductance and other specs.

Inputs

All Inputs are optically isolated to prevent the device for any kind of noise, short circuits.

- Enable: Required 5V DC input, Set high Input disabled the drive, Set low input Enable the drive
- Dir.: Required 5V DC input, Set high Input CW Rotation, Set low input CCW Rotation, Direction of the motor depends how stepper motor has been wired.
- CLK: Step Pulse required 5V DC TTL pulse

Outputs

4 Wires, 6 Wires, 8 Wires Motors can be used with this drive in bipolar mode.

On board LED for Alert

Data Sheet

Please read the Data sheet of Tb6600 for more information.

Clock Indicator

Power Indicator

Current Set Test Point
Test point (Voltage)

Motor Current
Adjust

Fault Indicator LED

Micro-Step Setting
Switch
1 M1
2 M2
3 M3
4 Latch (Auto Fault)

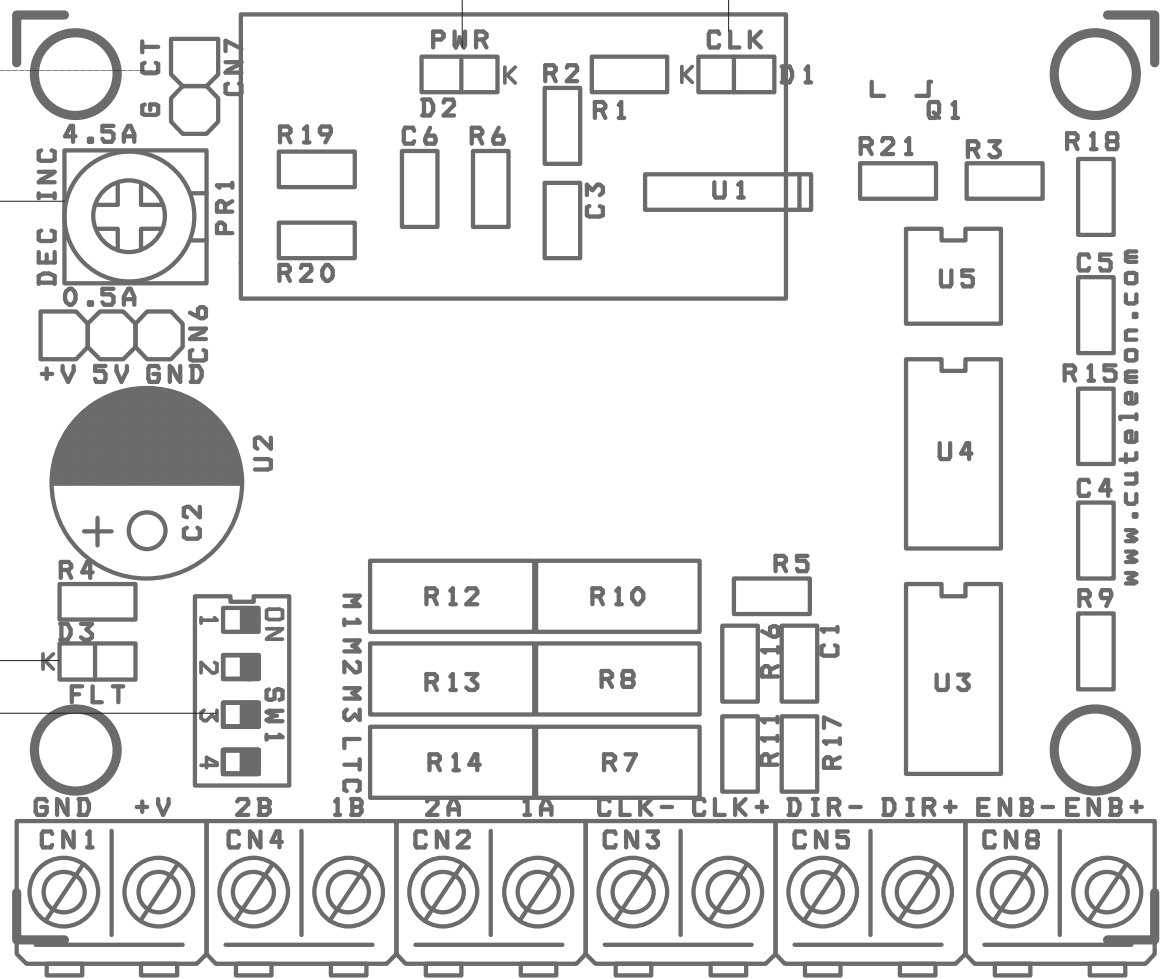
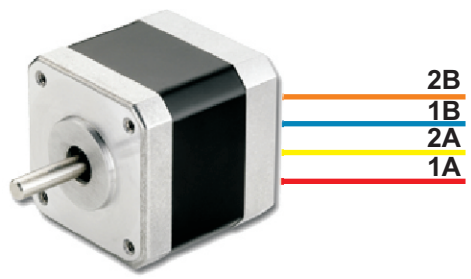
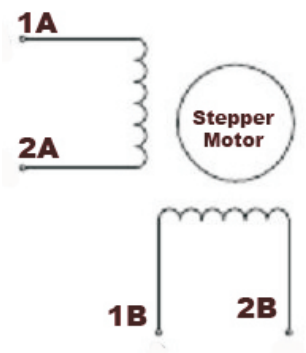

GND	+V	2B	1B	2A	1A	-	+	-	+	-	+
Supply		Stepper Motor			Step Pulse		Direction		Enable		

• Motor Supply 24V DC Advisable (10V to 42V DC input possible)
 • Step Pulse , Dir Pulse , Enable inputs required (5V TTL) please don't apply 24V